

MANUAL & MECHANICAL VALVES

PANEL MOUNT

3/2 WAY VALVES



Specification

Model	K3M3 - 05	K3M3 - 06	K3M3 - 08
Fluid	Air (to be filtered by 40µm filter element)		
Acting	Manual / Mechanical		
Port	M5	1/8"	1/4"
Orifice	2 mm	2.5 mm	15 mm
Valve Type	3/2		
Operating Pressure	0-0.8MPa (0-114psi)		
Proof Pressure	1.5MPa (215psi)		
Temperature	-20 to +70°C		
Material of Body	Aluminium		
Cv Value	0.11	0.14	0.84



Symbol

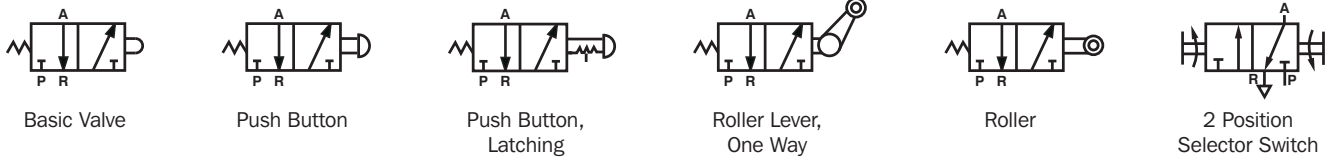

Ordering Code

K 3 M 3	—	P F	—	0 5	—	B
Model		Style		Port Size		Colour
K3M3 Manual & Mechanical 3/2 Way		B : Basic		05 : M5		B : Black
		R : Roller Lever		06 : 1/8"		G : Green
		V : Roller		08 : 1/4"		R : Red
		L : One Way Roller				
		Y : Lever/Lever				
		PF : Push Button (Shrouded)				
		PP : Push Button (External)				
		PM : Palm Button				
		PL : Palm Button (Latching Red only)				
		HS : 2 Position Selector				

Product Features

1. Valve core is manufactured to close tolerance and is fast acting
2. Lubrication is not necessary but once oil is added to the valve it must be continued
3. Multi-mounting makes it convenient to install and apply
4. Can be used without being panel mounted
5. Valves come complete with panel mount locknuts

Flow Charts

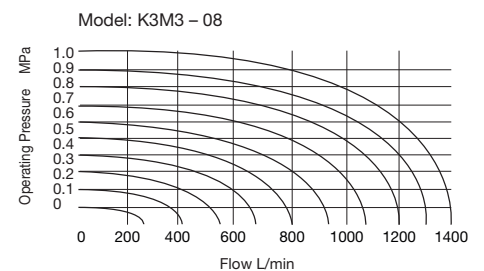
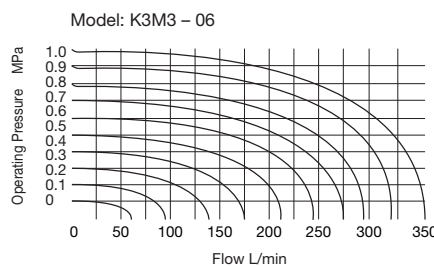
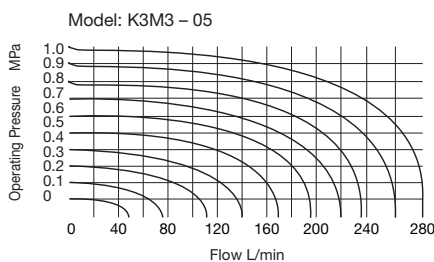

MANUAL & MECHANICAL VALVES

PANEL MOUNT

3/2 WAY VALVES



Dimensions

Basic Valve Body, M5

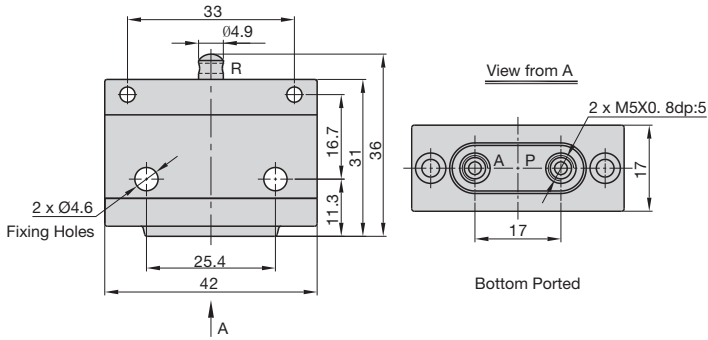

Roller Lever, M5 & 1/8"

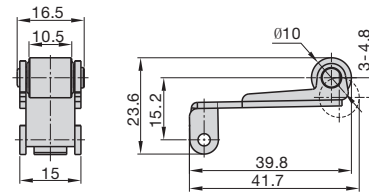

Basic Valve Body, 1/8"

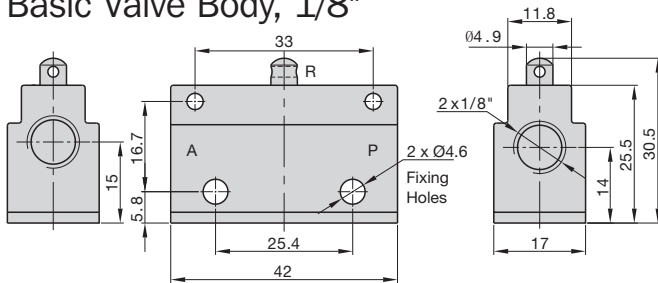

Roller Lever, 1/4"

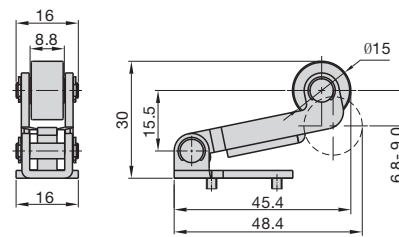

Basic Valve Body, 1/4"

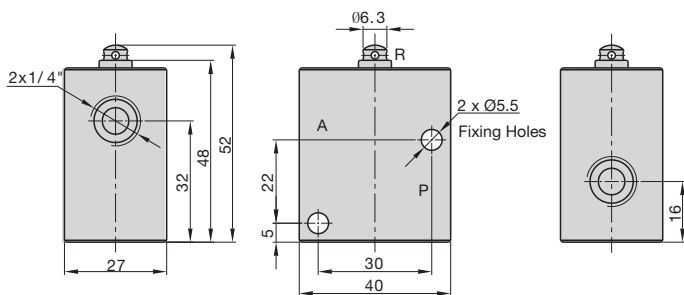

Roller Lever, One Way, M5 & 1/8"

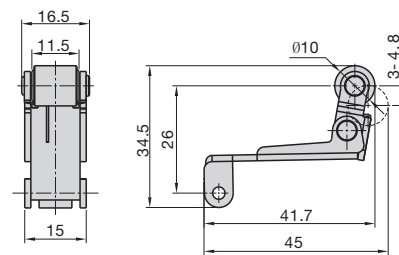

Roller Lever, One Way, 1/4"

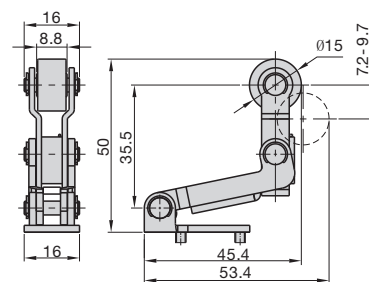

MANUAL & MECHANICAL VALVES

PANEL MOUNT

3/2 WAY VALVES



Dimensions

Roller, M5, 1/8" & 1/4"

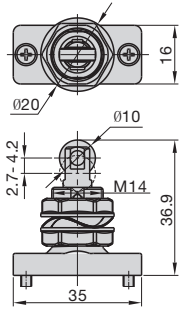

Palm Button, M5, 1/8" & 1/4"

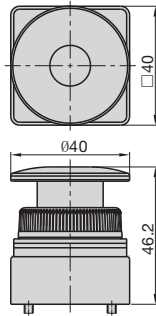

Push Button, M5, 1/8" & 1/4"

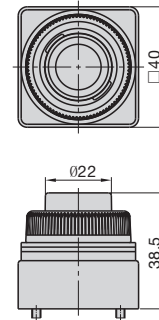

Lever/Lever, M5, 1/8" & 1/4"

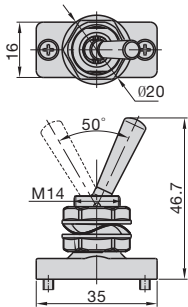

Palm Button, Latching, M5, 1/8" & 1/4"

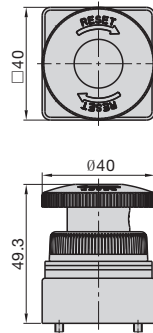

Push Button, Shrouded, M5, 1/8" & 1/4"

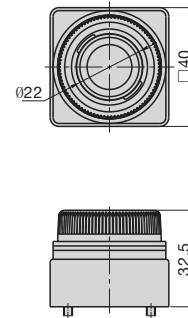

2 Position Selector Switch, M5, 1/8" & 1/4"

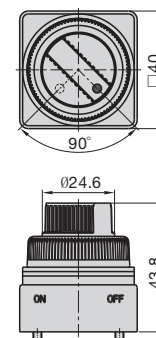

MANUAL & MECHANICAL VALVES PANEL MOUNT 3/2 WAY VALVES



No.	Item	No.	Item
1	Fixing Plate	12	Shaft
2	Screw	13	Lock Pin
3	Spacer	14	Roller Bracket
4	Body	15	Spring
5	Spring	16	O-ring
6	Spool	17	Screw
7	Connecting Gasket	18	O-ring
8	Connecting Holder	19	Bottom Cover Gasket
9	Clamping Nut	20	Spring
10	Spring Gasket	21	O-ring
11	Roller		

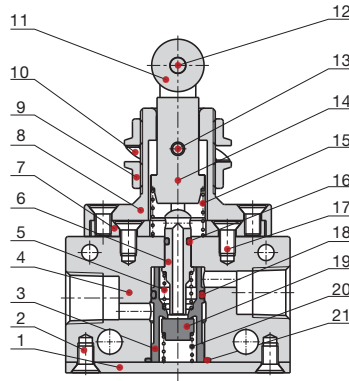

Installation & Operation

- Mechanical Valves K3M3B, K3M3R, K3M3V and K3M3L can be mounted side on. See Fig.1 for mounting.
- Model K3M3V can also be mounted using the panel mount nut as show in Fig.2 for mounting.
- Manual Valves K3M3Y, K3M3PF, K3M3PP, and K3M3HS see Fig.3 for mounting.
- Manual Valves K3M3PM and K3M3PL see Fig.4 for mounting.
- K3M3PM
Disassemble : Remove the palm button
Assemble : Once in position snap on the palm button
- K3M3PL, Latching Style
Disassemble : Remove the screw, and then remove the palm button
Assemble : Once in position re-fit the palm button and tighten fixing screw

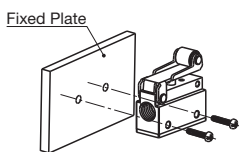

Fig.1

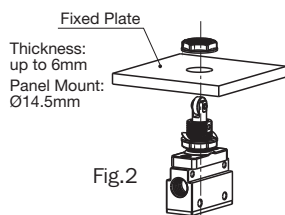

Fig.2

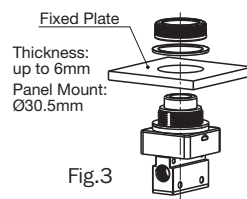

Fig.3

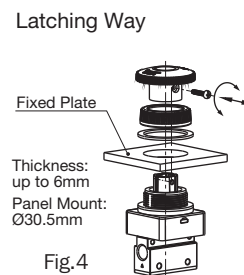

Fig.4

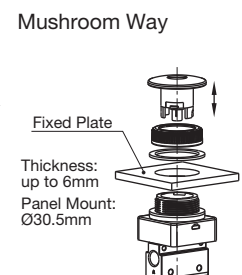

Fig.4